

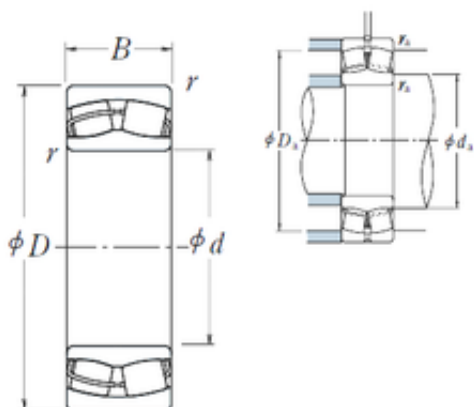

# BEARING CORP.OF AMERICA



## 130 mm x 200 mm x 69 mm NSK 24026CE4 Spherical Roller Bearing

Bearing No. 24026CE4

24026CE4 Bearing 2D drawings and 3D CAD models

Size	130x200x69 mm
Bore Diameter	130 mm
Outer Diameter	200 mm
Width	69 mm
d	130 mm
D	200 mm
B	69 mm
C	69 mm
r min.	2 mm
da min.	140 mm
da max	143 mm
Da min	175 mm
Da max.	190 mm
ra max.	2 mm
Weight	7,84 Kg
Basic dynamic load rating (C)	495 kN
Basic static load rating (C0)	865 kN
(Grease) Lubrication Speed	1400 r/min
(Oil) Lubrication Speed	1800 r/min
Calculation factor (e)	0,31
Calculation factor (Y0)	2,1
Calculation factor (Y2)	3,2
Category	Spherical Roller Bearings
Inventory	0.0
Manufacturer Name	NSK



## BEARING CORP.OF AMERICA

Minimum Buy Quantity	N/A
Weight / Kilogram	7.8
EAN	0029176076473
Product Group	B04311
Internal Clearance	C0-Medium
Mounting Method	Shaft Mount
Rolling Element	Spherical Roller Bearing
Bore Profile	Straight
Cage Material	Steel
Enclosure	Open
Number of Rows of Rollers	Double Row
Relubricatable	Yes
Withdrawal Sleeve	Not Applicable
Inch - Metric	Metric
Long Description	130MM Straight Bore; 200MM Outside Diameter; 69MM Width; C0-Medium Clearance; Shaft Mount; Double Row of Spherical Roller Bearings; Steel Cage Material; Open Enclosure; Relubricatable
Category	Spherical Roller Bearing
UNSPSC	31171510
Harmonized Tariff Code	84823080
Noun	Bearing
Keyword String	Spherical
Manufacturer URL	<a href="http://www.nskamericas.com">http://www.nskamericas.com</a>
Manufacturer Item Number	24026CE4
Weight / LBS	7.8
Adapter Part Number	Not Applicable Inch   Not Applicable Millimeter
Width	2.717 Inch   69 Millimeter
Outside Diameter	7.874 Inch   200 Millimeter



## BEARING CORP.OF AMERICA

Bore	5.118 Inch   130 Millimeter
Y3	2.2
hidYobi	24026CE4
LangID	1
Y1	2.2
D_	200
Y2	3.2
Macha rpm	0
B_	69
da min	140
hidTable	ecat_NSSPHR
Oil rpm	1800
Y0	2.1
mass	7.84
GRS rpm	1400
ra	2
TSR rpm	2200
C0	865
DE_	182.102
X0	1
Prod_Type3	SRB_CTB_CB
X1	1
X2	0.67
SIR	27.5
e	0.31
DA_	17.5
bomp	24026CE4
Z_	24
ALP2	45
ALP1	11
ALP3	0
D_a max	190



## BEARING CORP.OF AMERICA

D_a min	175
yobi	24026CE4
ALPHA_	0.205
SDM_	164.969
r	2
KBRG	2322
SBRG	40
DI_	147.836