

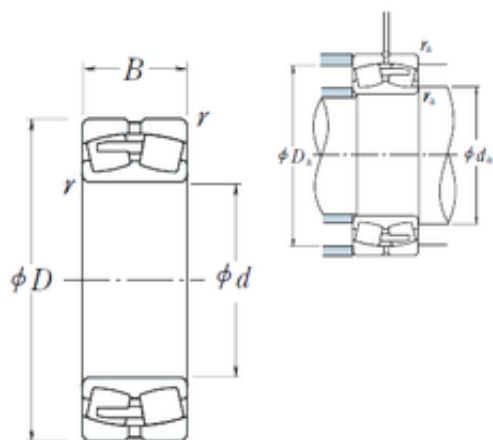

BEARING CORP.OF AMERICA



280 mm x 460 mm x 146 mm NSK 23156CAE4 Spherical Roller Bearing

Bearing No. 23156CAE4

Size	280x460x146 mm
Bore Diameter	280 mm
Outer Diameter	460 mm
Width	146 mm
d	280 mm
D	460 mm
B	146 mm
C	146 mm
r min.	5 mm
da min.	302 mm
Da min	400 mm
Da max.	438 mm
ra max.	4 mm
Weight	94,3 Kg
Basic dynamic load rating (C)	2230 kN
Basic static load rating (C0)	4000 kN
(Grease) Lubrication Speed	560 r/min
(Oil) Lubrication Speed	750 r/min
Calculation factor (e)	0,3
Calculation factor (Y0)	2,2
Calculation factor (Y2)	3,3

23156CAE4 Bearing 2D drawings and 3D CAD models