

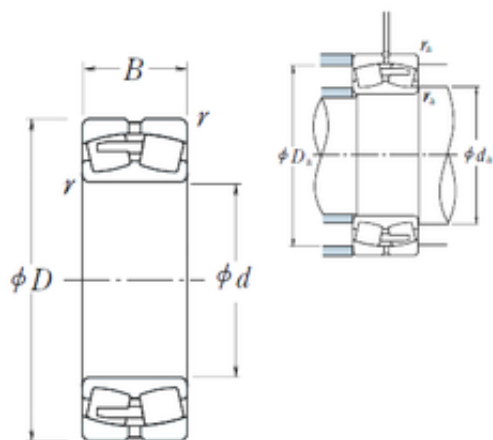

BEARING CORP.OF AMERICA



280 mm x 500 mm x 176 mm NSK 23256CAE4 Spherical Roller Bearing

Bearing No. 23256CAE4

Size	280x500x176 mm
Bore Diameter	280 mm
Outer Diameter	500 mm
Width	176 mm
d	280 mm
D	500 mm
B	176 mm
C	176 mm
r min.	5 mm
da min.	302 mm
Da min	425 mm
Da max.	478 mm
ra max.	4 mm
Weight	147 Kg
Basic dynamic load rating (C)	2880 kN
Basic static load rating (C0)	4900 kN
(Grease) Lubrication Speed	530 r/min
(Oil) Lubrication Speed	670 r/min
Calculation factor (e)	0,35
Calculation factor (Y0)	1,9
Calculation factor (Y2)	2,9

23256CAE4 Bearing 2D drawings and 3D CAD models