

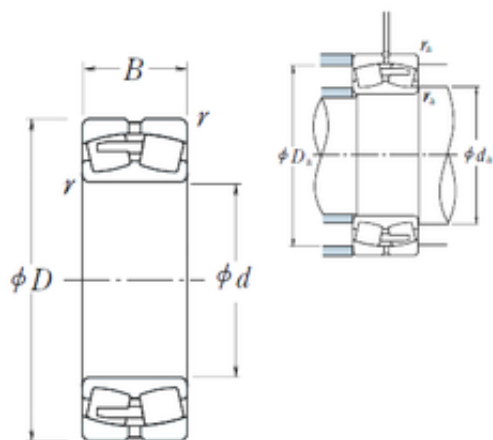

# BEARING CORP.OF AMERICA



## 300 mm x 500 mm x 200 mm NSK 24160CAE4 Spherical Roller Bearing

Bearing No. 24160CAE4

Size	300x500x200 mm
Bore Diameter	300 mm
Outer Diameter	500 mm
Width	200 mm
d	300 mm
D	500 mm
B	200 mm
C	200 mm
r min.	5 mm
da min.	322 mm
Da min	423 mm
Da max.	478 mm
ra max.	4 mm
Weight	152 Kg
Basic dynamic load rating (C)	3100 kN
Basic static load rating (C0)	5800 kN
(Grease) Lubrication Speed	500 r/min
(Oil) Lubrication Speed	670 r/min
Calculation factor (e)	0,38
Calculation factor (Y0)	1,7
Calculation factor (Y2)	2,6

24160CAE4 Bearing 2D drawings and 3D CAD models