

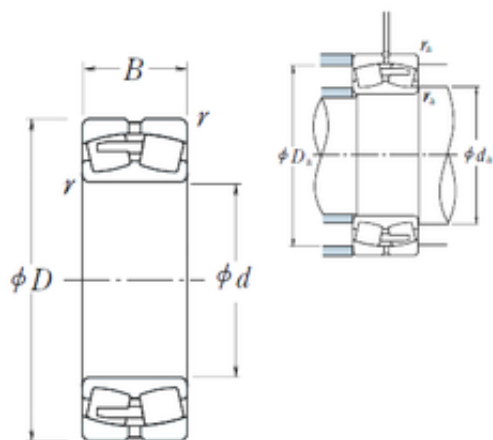

# BEARING CORP.OF AMERICA



## 320 mm x 580 mm x 150 mm NSK 22264CAE4 Spherical Roller Bearing

Bearing No. 22264CAE4

Size	320x580x150 mm
Bore Diameter	320 mm
Outer Diameter	580 mm
Width	150 mm
d	320 mm
D	580 mm
B	150 mm
C	150 mm
r min.	5 mm
da min.	342 mm
Da min	508 mm
Da max.	558 mm
ra max.	4 mm
Weight	174 Kg
Basic dynamic load rating (C)	2990 kN
Basic static load rating (C0)	4850 kN
(Grease) Lubrication Speed	530 r/min
(Oil) Lubrication Speed	670 r/min
Calculation factor (e)	0,26
Calculation factor (Y0)	2,6
Calculation factor (Y2)	3,9

22264CAE4 Bearing 2D drawings and 3D CAD models