

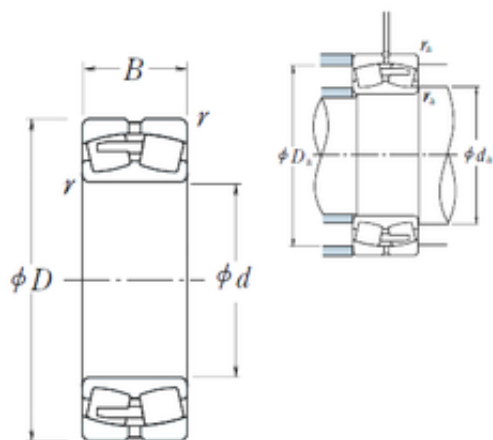

BEARING CORP.OF AMERICA



340 mm x 520 mm x 133 mm NSK 23068CAE4 Spherical Roller Bearing

Bearing No. 23068CAE4

Size	340x520x133 mm
Bore Diameter	340 mm
Outer Diameter	520 mm
Width	133 mm
d	340 mm
D	520 mm
B	133 mm
C	133 mm
r min.	5 mm
da min.	362 mm
Da min	465 mm
Da max.	498 mm
ra max.	4 mm
Weight	101 Kg
Basic dynamic load rating (C)	2280 kN
Basic static load rating (C0)	4400 kN
(Grease) Lubrication Speed	560 r/min
(Oil) Lubrication Speed	710 r/min
Calculation factor (e)	0,24
Calculation factor (Y0)	2,8
Calculation factor (Y2)	4,2

23068CAE4 Bearing 2D drawings and 3D CAD models