

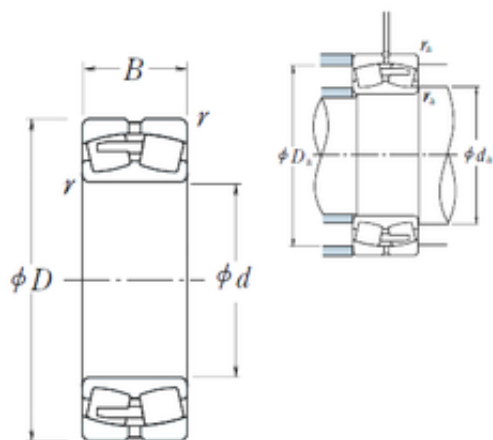

# BEARING CORP.OF AMERICA



## 360 mm x 540 mm x 134 mm NSK 23072CAE4 Spherical Roller Bearing

Bearing No. 23072CAE4

Size	360x540x134 mm
Bore Diameter	360 mm
Outer Diameter	540 mm
Width	134 mm
d	360 mm
D	540 mm
B	134 mm
C	134 mm
r min.	5 mm
da min.	382 mm
Da min	485 mm
Da max.	518 mm
ra max.	4 mm
Weight	106 Kg
Basic dynamic load rating (C)	2390 kN
Basic static load rating (C0)	4700 kN
(Grease) Lubrication Speed	530 r/min
(Oil) Lubrication Speed	670 r/min
Calculation factor (e)	0,24
Calculation factor (Y0)	2,8
Calculation factor (Y2)	4,2

23072CAE4 Bearing 2D drawings and 3D CAD models