

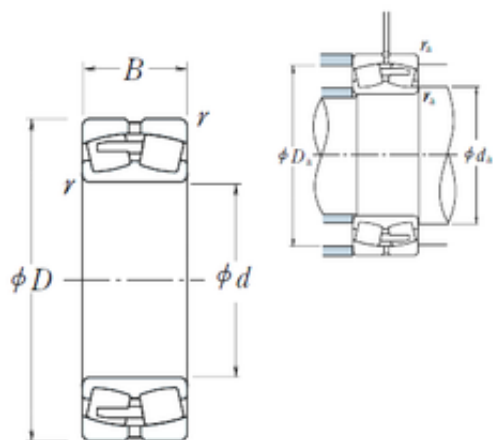

BEARING CORP.OF AMERICA



360 mm x 600 mm x 243 mm NSK 24172CAE4 Spherical Roller Bearing

Bearing No. 24172CAE4

Size	360x600x243 mm
Bore Diameter	360 mm
Outer Diameter	600 mm
Width	243 mm
d	360 mm
D	600 mm
B	243 mm
C	243 mm
r min.	5 mm
da min.	382 mm
Da min	507 mm
Da max.	578 mm
ra max.	4 mm
Weight	264 Kg
Basic dynamic load rating (C)	4200 kN
Basic static load rating (C0)	8000 kN
(Grease) Lubrication Speed	400 r/min
(Oil) Lubrication Speed	530 r/min
Calculation factor (e)	0,4
Calculation factor (Y0)	1,7
Calculation factor (Y2)	2,5

24172CAE4 Bearing 2D drawings and 3D CAD models