

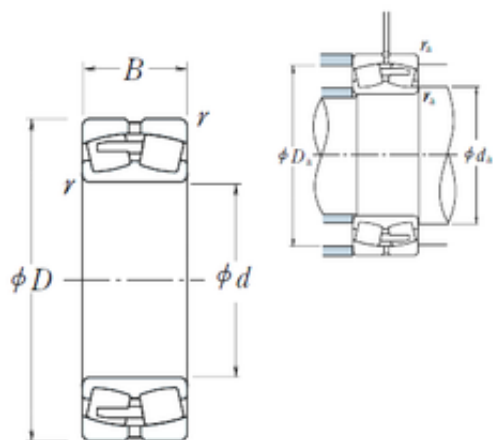

BEARING CORP.OF AMERICA



420 mm x 620 mm x 150 mm NSK 23084CAE4 Spherical Roller Bearing

Bearing No. 23084CAE4

Size	420x620x150 mm
Bore Diameter	420 mm
Outer Diameter	620 mm
Width	150 mm
d	420 mm
D	620 mm
B	150 mm
C	150 mm
r min.	5 mm
da min.	442 mm
Da min	562 mm
Da max.	598 mm
ra max.	4 mm
Weight	151 Kg
Basic dynamic load rating (C)	2910 kN
Basic static load rating (C0)	5850 kN
(Grease) Lubrication Speed	450 r/min
(Oil) Lubrication Speed	560 r/min
Calculation factor (e)	0,23
Calculation factor (Y0)	2,8
Calculation factor (Y2)	4,3

23084CAE4 Bearing 2D drawings and 3D CAD models