

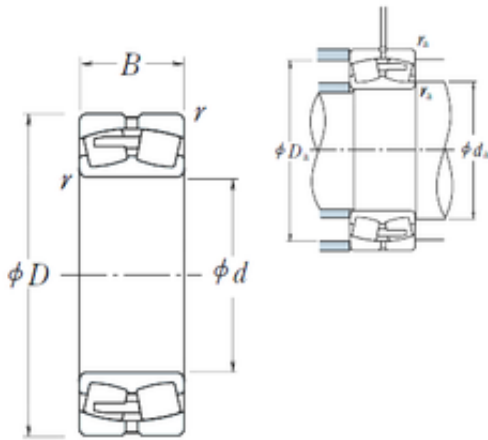

BEARING CORP.OF AMERICA

440 mm x 650 mm x 157 mm NSK 23088CAE4 Spherical Roller Bearing

Bearing No. 23088CAE4



23088CAE4 Bearing 2D drawings and 3D CAD models

Size	440x650x157 mm
Bore Diameter	440 mm
Outer Diameter	650 mm
Width	157 mm
d	440 mm
D	650 mm
B	157 mm
C	157 mm
r min.	6 mm
da min.	468 mm
Da min	587 mm
Da max.	622 mm
ra max.	5 mm
Weight	173 Kg
Basic dynamic load rating (C)	3150 kN
Basic static load rating (C0)	6350 kN
(Grease) Lubrication Speed	430 r/min
(Oil) Lubrication Speed	530 r/min
Calculation factor (e)	0,23
Calculation factor (Y0)	2,8
Calculation factor (Y2)	4,3