

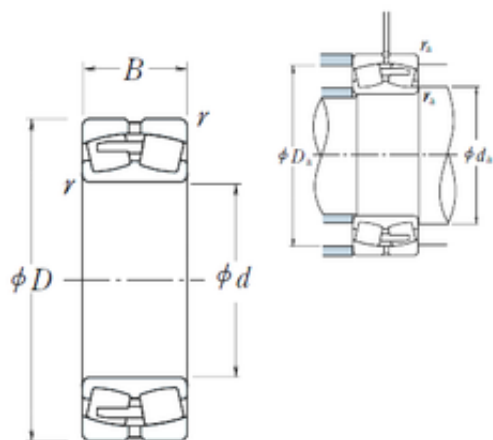

BEARING CORP.OF AMERICA

440 mm x 720 mm x 280 mm NSK 24188CAE4 Spherical Roller Bearing



Bearing No. 24188CAE4

Size	440x720x280 mm
Bore Diameter	440 mm
Outer Diameter	720 mm
Width	280 mm
d	440 mm
D	720 mm
B	280 mm
C	280 mm
r min.	6 mm
da min.	468 mm
Da min	617 mm
Da max.	692 mm
ra max.	5 mm
Weight	433 Kg
Basic dynamic load rating (C)	6000 kN
Basic static load rating (C0)	12100 kN
(Grease) Lubrication Speed	320 r/min
(Oil) Lubrication Speed	430 r/min
Calculation factor (e)	0,37
Calculation factor (Y0)	1,8
Calculation factor (Y2)	2,7

24188CAE4 Bearing 2D drawings and 3D CAD models