

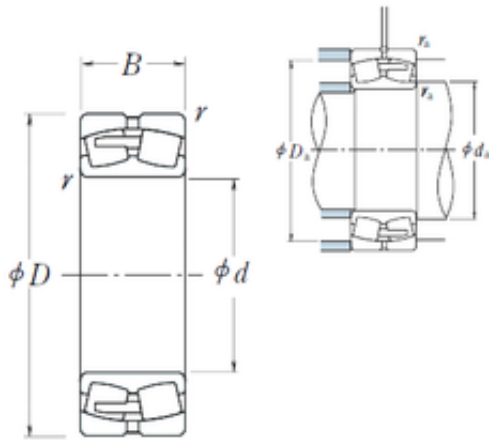

BEARING CORP.OF AMERICA

480 mm x 790 mm x 308 mm NSK 24196CAE4 Spherical Roller Bearing



Bearing No. 24196CAE4

Size	480x790x308 mm
Bore Diameter	480 mm
Outer Diameter	790 mm
Width	308 mm
d	480 mm
D	790 mm
B	308 mm
C	308 mm
r min.	7,5 mm
da min.	516 mm
Da min	670 mm
Da max.	754 mm
ra max.	6 mm
Weight	567 Kg
Basic dynamic load rating (C)	7150 kN
Basic static load rating (C0)	14600 kN
(Grease) Lubrication Speed	300 r/min
(Oil) Lubrication Speed	380 r/min
Calculation factor (e)	0,39
Calculation factor (Y0)	1,7
Calculation factor (Y2)	2,6

24196CAE4 Bearing 2D drawings and 3D CAD models