

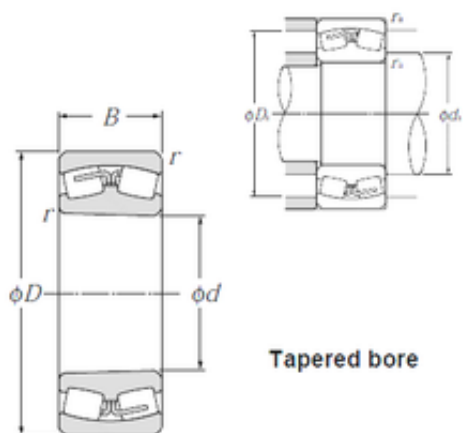

# BEARING CORP.OF AMERICA

## 170 mm x 280 mm x 88 mm NTN 23134BK Spherical Roller Bearings



Bearing No. 23134BK

Size	170x280x88 mm
Bore Diameter	170 mm
Outer Diameter	280 mm
Width	88 mm
d	170 mm
D	280 mm
B	88 mm
C	88 mm
r min.	2,1 mm
da min.	182 mm
Da max.	268 mm
ra max.	2 mm
Weight	20,8 Kg
Basic dynamic load rating (C)	885 kN
Basic static load rating (C0)	1 490 kN
(Grease) Lubrication Speed	1 200 r/min
(Oil) Lubrication Speed	1 500 r/min
Calculation factor (e)	0,31
Calculation factor (Y0)	2,11
Calculation factor (Y1)	2,15

23134BK Bearing 2D drawings and 3D CAD models